

# Unit Three: Teaching Through Problem Solving

From the module:  
*Teaching and Learning Mathematics in Diverse Classrooms*





# Copyright

© South African Institute for Distance Education (SAIDE), 2008



The work is licensed under the **Creative Commons Attribution-Non-commercial-Share Alike 2.5 South Africa License**. To view a copy of this license, visit

<http://creativecommons.org/licenses/by-nc-sa/2.5/za>



**South African Institute for Distance Education**  
PO Box 31822  
Braamfontein  
2017  
South Africa

Fax: +27 11 4032814  
E-mail: [info@saide.org.za](mailto:info@saide.org.za)  
Website: [www.saide.org.za](http://www.saide.org.za)



# Acknowledgements

The South African Institute for Distance Education (SAIDE) wishes to thank those below:

For adapting and revising the module

- Ingrid Sapire – writer
- Tony Mays – writer
- Commonwealth of Learning (COL) – for the OER instructional design template
- Andre Plant – for the illustrations
- Tessa Welch – project manager

For participation in preparing and piloting the module

- Sam Kaheru / Nicholas Muthambi (University of Venda)
- Sharon Mc Auliffe (Cape Peninsula University of Technology)
- Ronel Paulsen / Barbara Posthuma (University of South Africa)
- Tom Penlington (RUMEP at Rhodes University)
- Thelma Rosenberg / Sally Hobden (University of KwaZulu-Natal)
- Ingrid Sapire (RADMASTE Centre, University of the Witwatersrand)
- Judith Inglis (University of the Witwatersrand)
- Marinda van Zyl / Lonnie King (Nelson Mandela Metropolitan University)

For permission to adapt the following study guide for the module

- UNISA (2006). *Learning and teaching of Intermediate and Senior Mathematics (ACE ME1-C)*. Pretoria: UNISA

For permission to use in Unit Three

- UNISA (2006). Study Unit 4 from *Learning and Teaching of Intermediate and Senior Phase Mathematics*.
- Malati (1999). *Geometry activities: Geometry Module 3: Representations (nets, models and cross sections)*, Grades 4 to 7 Learner Materials.
- RADMASTE Centre, University of the Witwatersrand (2006). *Mathematical Reasoning* (EDUC 263) Chapter 7.



# Contents

<b>How the unit fits into the module</b>	<b>1</b>
Overview of content of module .....	1
How the unit is structured .....	3
<b>Unit Three: Teaching Through Problem Solving</b>	<b>5</b>
Welcome .....	5
Unit outcomes .....	6
Introducing problem solving .....	7
Discussion of case studies .....	9
What then is problem solving? .....	10
Developing problem-solving tasks .....	11
Problem-solving activities for space and shape .....	11
Routine and non-routine problems .....	13
Starting where the learners are .....	14
Developing different kinds of mathematics ideas .....	19
Concepts and relationships constructed by connecting ideas .....	21
Developing procedures and processes .....	22
Good problems have multiple entry points .....	26
Designing and selecting effective tasks .....	26
A three-part lesson format .....	28
Before, during and after .....	28
Teacher's actions in the before phase .....	29
Things to think about .....	30
Teacher's actions in the during phase .....	31
Teacher's actions in the after phase .....	31
Working towards problem-solving goals .....	33
Different levels of cognitive demands in tasks .....	34
The value of teaching using a problem based approach .....	38
Unit summary .....	39
Self assessment .....	40
References .....	41





# How the unit fits into the module

---

## Overview of content of module

The module *Teaching and Learning Mathematics in Diverse Classrooms* is intended as a guide to teaching mathematics for in-service teachers in primary schools. It is informed by the inclusive education policy (Education White Paper 6 Special Needs Education, 2001) and supports teachers in dealing with the diversity of learners in South African classrooms.

In order to teach mathematics in South Africa today, teachers need an awareness of where we (the teachers and the learners) have come from as well as where we are going. Key questions are:

Where will the journey of mathematics education take our learners? How can we help them?

To help learners, we need to be able to answer a few key questions:

- What is mathematics? What is mathematics learning and teaching in South Africa about today?
- How does mathematical learning take place?
- How can we teach mathematics effectively, particularly in diverse classrooms?
- What is ‘basic’ in mathematics? What is the fundamental mathematical knowledge that all learners need, irrespective of the level of mathematics learning they will ultimately achieve?
- How do we assess mathematics learning most effectively?

These questions are important for all learning and teaching, but particularly for learning and teaching mathematics in diverse classrooms. In terms of the policy on inclusive education, all learners – whatever their barriers to learning or their particular circumstances in life – must learn mathematics.

The units in this module were adapted from a module entitled *Learning and Teaching of Intermediate and Senior Mathematics*, produced in 2006 as one of the study guide for UNISA’s Advanced Certificate in Education programme.

The module is divided into six units, each of which addresses the above questions, from a different perspective. Although the units can be studied separately, they should be read together to provide comprehensive guidance in answering the above questions.

### Unit 1: Exploring what it means to 'do' mathematics

This unit gives a historical background to mathematics education in South Africa, to outcomes-based education and to the national curriculum statement for mathematics. The traditional approach to teaching mathematics is then contrasted with an approach to teaching mathematics that focuses on 'doing' mathematics, and mathematics as a science of pattern and order, in which learners actively explore mathematical ideas in a conducive classroom environment.

### Unit 2: Developing understanding in mathematics

In this unit, the theoretical basis for teaching mathematics – constructivism – is explored. Varieties of teaching strategies based on constructivist understandings of how learning best takes place are described.

### Unit 3: Teaching through problem solving

In this unit, the shift from the rule-based, teaching-by-telling approach to a problem-solving approach to mathematics teaching is explained and illustrated with numerous mathematics examples.

### Unit 4: Planning in the problem-based classroom

In addition to outlining a step-by-step approach for a problem-based lesson, this unit looks at the role of group work and co-operative learning in the mathematics class, as well as the role of practice in problem-based mathematics classes.

### Unit 5: Building assessment into teaching and learning

This unit explores outcomes-based assessment of mathematics in terms of five main questions – Why assess? (the purposes of assessment); What to assess? (achievement of outcomes, but also understanding, reasoning and problem-solving ability); How to assess? (methods, tools and techniques); How to interpret the results of assessment? (the importance of criteria and rubrics for outcomes-based assessment) ; and How to report on assessment? (developing meaningful report cards).

### Unit 6: Teaching all children mathematics

This unit explores the implications of the fundamental assumption in this module – that ALL children can learn mathematics, whatever their background or language or sex, and regardless of learning disabilities they may have. It gives practical guidance on how teachers can adapt their lessons according to the specific needs of their learners.

During the course of this module we engage with the ideas of three teachers - Bobo Diphoko, Jackson Segoe and Millicent Sekesi. Bobo, Jackson and Millicent are all teachers and close neighbours.

Bobo teaches Senior Phase and Grade 10-12 Mathematics in the former Model C High School in town;

Jackson is actually an Economics teacher but has been co-opted to teach Intermediate Phase Mathematics and Grade 10-12 Mathematical Literacy at the public Combined High School in the township;

Millicent is the principal of a small farm-based primary school just outside town. Together with two other teachers, she provides Foundation Phase learning to an average 200 learners a year.

Each unit in the module begins with a conversation between these three teachers that will help you to begin to reflect upon the issues that will be explored further in that unit. This should help you to build the framework on which to peg your new understandings about teaching and learning Mathematics in diverse classrooms.

---

## How the unit is structured

The unit consists of the following:

- Welcome to the unit – from the three teachers who discuss their challenges and discoveries about mathematics teaching.
- Unit outcomes.
- Content of the unit, divided into sections.
- A unit summary.
- Self assessment.
- References (sources used in the unit).

Unit Three takes the ideas of Unit One further by expanding on problem solving at length, as a method of teaching that can allow learners to ‘do mathematics’ and through this build up their understanding of mathematics.

There are four main sections:

- 1 Introducing problem solving
- 2 Developing problem solving tasks
- 3 A three-part lesson format
- 4 The value of using a problem based approach.



# Unit Three: Teaching Through Problem Solving

## Welcome



The conversation between Jackson, Millicent and Bobo continues...

Jackson remarked that previously they had discussed the fact that children think through maths problems in diverse ways, but he noted that teachers also teach in diverse ways. He went on to tell Millicent and Bobo about a small bit of research he had undertaken into how two of his colleagues, Mr Ntombela and Ms Khumalo taught the concept of fractions.

Before we join them in their discussions, have a look through the intended learning outcomes for this unit.

---

## Unit outcomes



### Outcomes

Upon completion of Unit Three you will be able to:

- Motivate, with understanding, the need for a shift in thinking about mathematics instruction.
- Critically reflect on the value of teaching with problems.
- Select and analyse appropriate tasks and problems for learning mathematics.
- Describe, with insight, the three-part lesson format for problem solving referred to as before, during and after.
- Critically describe the teacher's actions in the before, during and after phases of a problem-solving lesson.
- Competently select and design effective problem-based lessons from the textbook and other resources.
- Explain competently how problem-solving goals are developed while students learn.

## Introducing problem solving

We begin our discussion with an activity so that we can build upon your own current experience and understanding. This should help you better to engage with the discussion that follows.

Working with fractions is often a challenge for both children and adults. We will therefore explore the teaching of fractions as a practical introduction to this unit.



### Activity 1

#### Working with fractions

How would YOU teach children how to ‘add’ fractions?

On the following pages are the two case studies that Jackson told Millicent and Bobo about from his research.

In these two classrooms we see how other teachers teach the concept of fractions.

Read through the two case studies and then answer the questions that follow.

- 1 Which of these two approaches is most like the way that you teach?
- 2 Which of these two approaches do you prefer and why?
- 3 Which of these two approaches allows for meaningful construction of ideas? Explain your answer.



## Case Study A

Case study A: Mr Ntombela		
What the teacher says	What is on the chalkboard	What the learners do
In this lesson we are going to learn to add two fractions.		Listen.
Let us suppose we want to add these two fractions ...	$\frac{1}{3} + \frac{1}{6} = ?$	Listen and watch.
We cannot add them straightaway because they have different denominators. First we need to find a common factor. What is the lowest common factor?	<b>LCF = 6</b>	Listen, watch and put up their hands to answer the teacher's question.
Now we need to multiply the numerator by the same amount as the denominator.	$\frac{1 \times 2}{3 \times 2} + \frac{1}{6} = ?$	Listen and watch.
Now we can add the numerators together like we do normally to get the answer.	$\frac{2}{6} + \frac{1}{6} = \frac{3}{6}$	Listen and watch.
Now use this example to try questions 1 to 10, in exercise 7 on page 15 of your text.		Work individually and silently on the exercise. Put up their hands if they need help.





## Case Study B

### Case study B: Ms Khumalo

Ms Khumalo says:

*In the last two lessons we talked about fractions. Can anybody remember what a fraction is? Can you give me some examples?*

*In this lesson I want to see if we can use what we already know to solve a problem. We will work in pairs.*

*Listen carefully to the problem: Mpho and Thabo were each given a bar of chocolate in their lunch box. On the way to school they decided to eat some of their chocolate. Now Mpho has only a third of her chocolate bar left and Thabo has only a sixth of his chocolate bar left.*

*How much chocolate do they have left between them? Try drawing diagrams to show how much chocolate they have left.*

She provides several similar problems on task cards.

She then asks one of the learners to explain how they solved the problems and invites other learners to ask questions and to propose alternatives.

Only once she is convinced that the learners understand the concept does she get them to think about the more formal 'quick' way of doing it.

The learners attempt two similar problems (fifths and tenths, quarters and eighths) and one more difficult example (thirds and quarters) for homework and for discussion in class the following day.

### Discussion of case studies

The first approach in Case Study A, that of proceeding directly to formal mathematics and the use of 'rules', has the advantage that it is quick and easy for the teacher and some students will be able to 'read between the lines' and answer similar questions correctly.

A disadvantage of the first approach is that if learners misunderstand or misapply the rule, they will usually not realise they have made a mistake and may not be able to think their way through to a correct solution. This approach will often lead to errors like the following:

$$\frac{1}{3} + \frac{2}{6} = \frac{3}{9}$$

The second approach in Case Study B has the disadvantage that it is initially more time consuming, both in terms of planning outside the classroom and the time taken to complete and discuss tasks inside the classroom. In addition, the fact that the teacher has not specified any rules to follow means that she must be able to cope with a variety of divergent, and sometimes erroneous, thinking. An advantage of this approach is that learners get to talk about and explore the issues in a meaningful way.

With support and guidance from their peers and the teacher, they should be able to reason their way through the underpinning principles and not only avoid the kind of error outlined above but also be better able to think their way through more irregular examples. They should also need less drilling.

The second approach focuses on problem solving as a way of developing understanding of the concepts involved.

### What then is problem solving?

At the outset it is necessary to draw a distinction between problem solving and the doing of routine exercises. Nicholson (1992) explains:

*In problem solving one finds the solution to a particular situation by a means which was not immediately obvious.*

*A problem-solving task is one that engages the learners in thinking about and developing the important mathematics they need to learn.*

This can be contrasted with the traditional or stereotypical approach to teaching in which teachers explain a rule, provide an example and then drill the learners on similar examples.

Problem solving has been described by many authors and researchers (e.g. Nicholson: 1992) as the essence of mathematics, and yet many learners spend most of their time on routine exercises. It must be stressed that whether something is a problem or not is dependent on the level of sophistication of the problem solver. A learner in grade 8 may be required to solve a problem in which the method and solution are not obvious, and yet the same problem given to an older child may be quite routine.

Hiebert et al (1997) have brought the **problem-solving approach** for the teaching and learning of mathematics **with understanding** to the fore when they state:

*We believe that if we want students to understand mathematics, it is more helpful to think of understanding as something that results from solving problems, rather than something we can teach directly.*

Problem solving has been espoused as a goal in mathematics education since late 1970, with focused attention arising from NCTM's *An Agenda for Action*' (Campbell & Boamberger: 1990).

However, problem solving should be more than a slogan offered for its appeal and widespread acceptance – it should be a cornerstone of mathematics curriculum and instruction, fostering the development of mathematical knowledge and a chance to **apply and connect previously constructed mathematical understanding**.

This view of problem solving is presented in the *Revised National Curriculum Statement for R-9 (schools)* (Department of Education – Mathematics: 2001,16-18)

*Problem solving should be a primary goal of all mathematics instruction and an integral part of all mathematical activity. Learners should use problem-solving approaches to investigate and understand mathematical content.*

A significant proportion of human progress can be attributed to the unique ability of people to solve problems. Not only is problem solving a critical activity in human progress and even in survival itself, it is also an extremely interesting activity.

## Developing problem-solving tasks

### Problem-solving activities for space and shape

In this section we look at a variety of different problem-solving tasks in order to identify the characteristic features that will help us to design our own examples. We will start with an example of an activity that explores space and shape to illustrate some general issues and then we will focus in on particular aspects of problem solving for different conceptual areas.

 <p>Activity 2</p>	<p>Think about how YOU would teach learners to understand 3-dimensional shapes.</p> <p>Then consider the example on the next page which uses a problem-solving approach.</p> <p>Would you use an example like this in your teaching? Why/Why not?</p>
---	---

**Example A****Example A: Understanding three-dimensional shapes**

You will need old magazines and newspapers for this activity.

- 1 Find pictures of three-dimensional objects in the magazines and newspapers.
- 2 Cut these out and paste them onto paper.
- 3 Give each object a name that describes its shape.
- 4 Explain how you know what the object is.
- 5 Try to find pictures of as many different objects as you can.

Here is an example: This is a picture of a rectangular prism.  
It has 6 faces. Each face is a rectangle.



This is how you will be assessed:

- Can you identify the objects in the pictures?
- Do you find pictures that have a variety of different objects?
- Can you name the objects?
- Can you write down your reasons for naming the objects?
- Can you explain your reasons to the teacher?
- Is your work neatly presented?

In this unit, many of the problems and activities relate to LO3 from the Mathematics NCS, which deals with Space and Shape, or what in previous curriculum documents in South Africa was referred to as Geometry. This will give you an opportunity to develop your own understanding of some fundamental concepts in the area of Space and Shape.

Learners need to become acquainted with more detailed descriptions of features of 3-D objects. They need to engage in the process of mathematisation. Teachers can be guided by the theory of van Hiele about the various levels of geometric understanding. Fundamental knowledge all learners should acquire about shapes should not only be the recognition of shapes and the classification of these shapes, but also

- what the properties of shapes are (level 1),
- the relationships among the properties (level 2), and
- the deductive systems of properties (level 3).

Appropriate activities should be found, that cover these levels, by teachers, to work through with the learners. A practical approach where learners manipulate real objects will enable them to become familiar with the shapes and their properties.

The example above illustrates a key characteristic of a problem-solving approach: it provides for learners to explore the concept in practical and different ways.

Another key characteristic of a problem-solving approach is the focus on equipping learners to tackle non-routine problems.

## Routine and non-routine problems

Tasks or problems can and should be posed that engage the learners in thinking about and developing the important mathematics they need to learn.

As noted in the introduction, the traditional or stereotypical approach to teaching goes something like this:

- The teach-by-telling approach provides a rule.
- The teacher accompanies the rule with a conceptual explanation (perhaps with pictures so that learners will see the concepts).
- The learners are aware of the exercises to come, and how to do them.

However, the explanation is of little value since the rule is all that is necessary to get through the day. An atmosphere that promotes curiosity, which encourages learners to test their own hypotheses and pursue their own predictions, is lacking: they are not encouraged to create and invent

their own constructions or ideas.



### Activity 3

#### Routine or non-routine?

Given below is a list of problems suitable for learners in the Intermediate phase.

Select the problems that you would consider as routine for the learners.

Select the problems that you would consider as non-routine.

#### Problems

- 1 Subtract 0,379 from 0,574
- 2 Calculate  $12 \times (2 + 5 + 4)$
- 3 Find the sum of the following number sequence without adding all the numbers. Write down a rule:  
 $1 + 3 + 5 + \dots + 97 + 99$
- 4 Calculate:  $\frac{1}{2} \times \frac{3}{7}$
- 5 If 372 is added to a certain number then the sum is 8418. What is the number?
- 6 Solve  $3x - 7 = 5$
- 7 A builder is building a new house. He worked out that 2 painters should be able to complete the painting in 11 days. Each painter works an 8 hour day at R7 per hour. The paint cost R1260. How much money will be spent on having the house painted?

Providing learners with opportunities to explore concepts in their own ways and equipping them to deal with non-routine tasks begs the question: Where do we start?

In mathematics, as in other areas of the curriculum, we need to think back to one of the key principles we all learned about in our initial teacher training: moving from the known to the unknown. That means starting from where the learners are and then presenting them with a problem that challenges them to extend their thinking.

### Starting where the learners are

The stereotypical traditional approach to mathematics teaching goes something like this:

- The teacher gives input.
- The learners practise for a while.

- The learners are expected to use the skills in solving typical problems.

This approach has its problems, as Van de Walle points out (2005: 37):

*The first difficulty with this approach is that it begins where the teacher is rather than where the learner is. It assumes that all learners will be able to make sense of the explanation in the manner the teacher thinks best.*

*The second difficulty with the teach-then-solve approach is that problem solving is separated from the learning process. The learners expect the teacher to tell them the rules and are unlikely to solve problems for which solution methods have not been provided. In essence, learning mathematics is separated from 'doing mathematics'. This does not make sense.*

**How can lessons become more effective?**

Consider the following:

- Begin where the learners are, not where we as teachers are.
- Teaching should begin with the ideas that learners already have – the ideas they will use to create new ones.
- Engage the learners in tasks or activities that are problem-based and require thought.

**What does this mean in practice?**

First of all we need to understand what a problem is. A problem is any task or activity for which the learners have no prescribed or memorized rules or methods. The learners should also not have the perception that there is a specific 'correct' solution or method.

In setting a problem for learners, teachers should make sure that it

- begins where the learners are
- engages learners on the aspect of mathematics they are required to learn
- requires learners to explain and justify their methods as well as their answers.

The methods used may be various: they can involve hands-on material or drawings; they can be simply pencil-and-paper tasks; they may be strictly mental work, and calculators may or may not be used.

What is critical, though, is that if the mathematics is to be taught through problem solving, then the tasks or activities are the vehicle by which the desired curriculum is developed. Teachers don't teach the concepts first, and then require learners to do exercises – the problem-solving activity is the vehicle through which the concepts are taught.

Below are some examples of activities for investigating the properties of shapes.

 <p><b>Activity 4</b></p>	<p><b>Investigating the properties of shapes</b></p> <p>Evaluate each example against each of the three ‘features’ identified earlier. Does it:</p> <ul style="list-style-type: none"> <li>▪ begin where the learners are?</li> <li>▪ engage learners on the aspect of mathematics they are required to learn?</li> <li>▪ require learners to explain and justify their methods as well as their answers?</li> </ul> <p>Where necessary suggest ways in which the examples might need to be improved.</p>
--	---

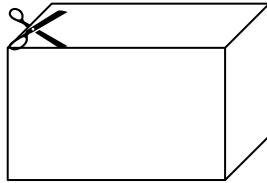
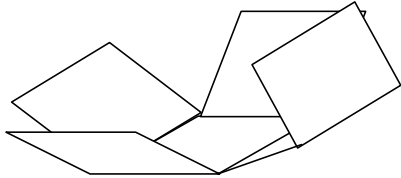
 <p><b>Example B</b> (Malati, 1999)</p>	<p><b>Example B: Unfolding boxes</b></p> <p>Take a cardboard box like this:</p>  <p>Cut the edges of the box so that you can open it up and lie it flat: and :</p>  <p>Draw the flat box in this space:</p> <div style="border: 1px solid black; border-radius: 15px; padding: 10px; width: fit-content; margin-left: auto; margin-right: auto;"> <p>The flattened figure is called the net of the box.</p> </div> <p>Compare the net you have drawn to that of your classmates.</p>
---	--





**Example C**  
(Malati, 1999)

**Example C: An open box**

This is a drawing of a cube *without a top*.



- 1 Which of the nets below can be folded to make this box?
  - If the net cannot be used to make this box, explain why not.
  - If the net can be folded to make the box, colour the square that will form the bottom of the box.

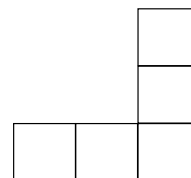
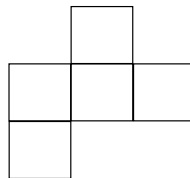
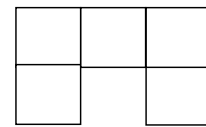
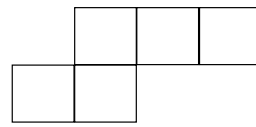
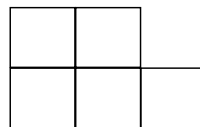
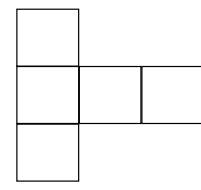
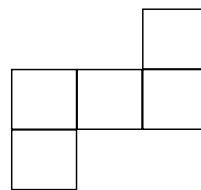
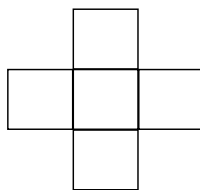

- 2 Try to draw a different net for this box and colour the square that will form the bottom of this box.
- 3 Now draw the net of a cubic box that does have a lid.



- 4 How many different nets can you draw for this box?



**Example D**  
(Malati, 1999)

**Example D: Matching edges, faces and vertices**

The diagram below shows the net of a rectangular prism. The edges are labelled with small letters.

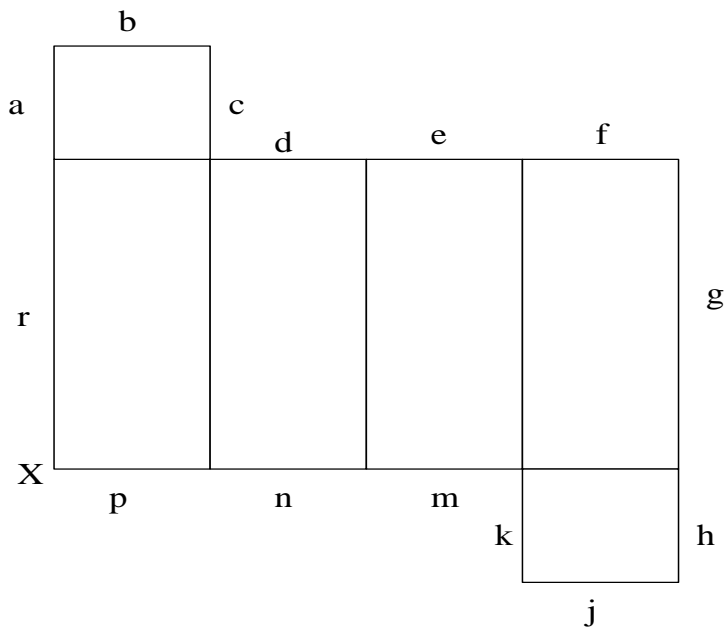

Copy the net onto a blank sheet of paper, label the edges as they have been labelled here, but write your labels inside the net, so that you can cut out the net and fold it to help you to answer the following questions.

- 1 Which edge of the net will fold onto edge  $g$ ?
- 2 Which edge of the net will fold onto edge  $c$ ?
- 3 Which edge of the net will fold onto edge  $n$ ?
- 4 How many faces will the complete, folded prism have?
- 5 How many edges will the complete, folded prism have?
- 6 How many vertices will the complete, folded prism have?

You should have noticed that Example B paves the way for Example C which in turn helps to develop some of the necessary understandings to tackle Example D. The examples illustrate the way in which we move from where the learners are to where they need to be both within individual problem-based activities and across a series of problem-based activities and lessons. Problem-solving can be used to explore and develop many different mathematics ideas, not just those associated with shape and space.

## Developing different kinds of mathematics ideas

Remember that, as we said above, a problem is any task or activity for which the learners have no prescribed or memorised rules or methods. The learners should also not have the perception that there is a specific ‘correct’ solution or method.

In Unit Two, we categorised mathematical ideas as conceptual or procedural. In this unit, we will show that children can learn both types of mathematical ideas through problem-based activities.



### Activity 5

#### Developing conceptual understanding

What kinds of mathematical thinking are encouraged by the following example of an activity you could give your learners?

*How many ways can you break up the number 6?*

- 1 Think about the number 6 broken into two different amounts.
- 2 Draw a picture to show a way that six things can be put into two different parts.
- 3 Think up a story to go with your picture.

This is an example of the kind of construction that could be made by the learners:

**STORY:**

Six rand is shared between Peter and Paul. The sharing can take place in the following different ways.

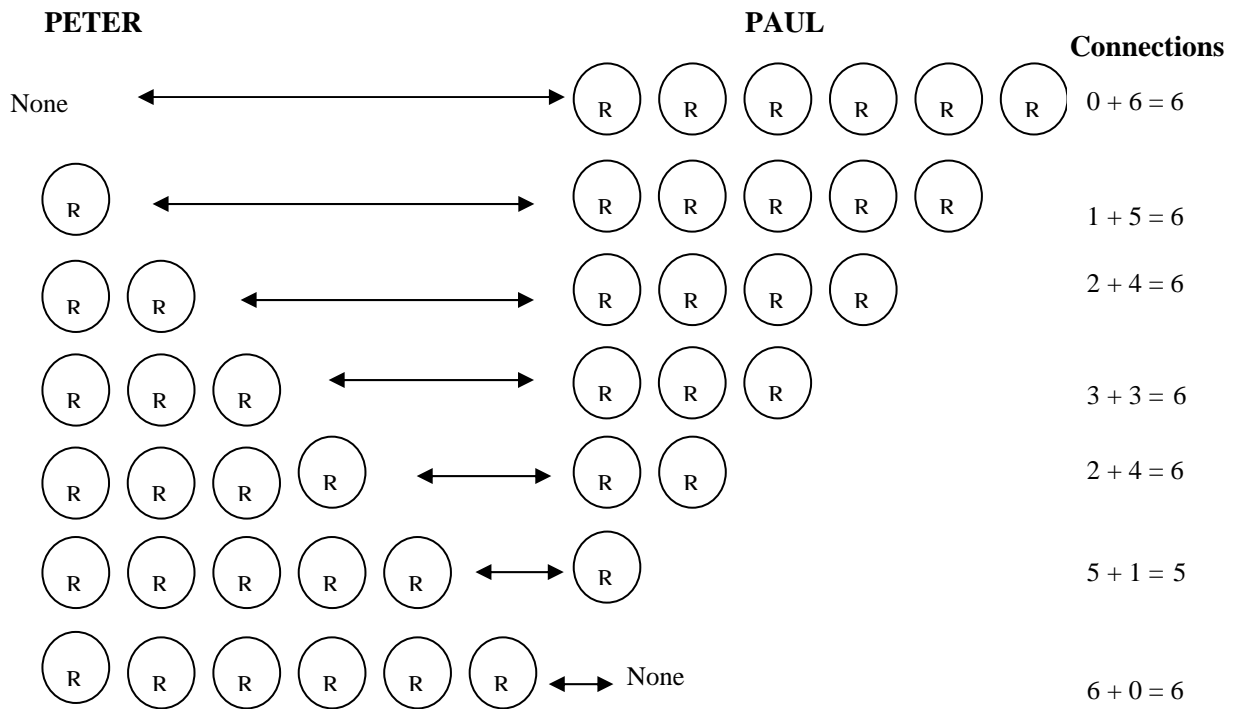

This example illustrates the way in which problem solving can be used to develop conceptual understanding using money as a context.

We identified the following kinds of conceptual thinking learners may have been actively involved in while working through this problem. Perhaps you can add to our ideas?

### Concepts and relationships constructed by connecting ideas

- The operation (+) is further constructed (or reinforced). Addition is a mathematical concept.
- The relationship: The sum of two numbers is the same (equals to 6) if the first number is increased by one, and the other decreased by one. Relationships are mathematical concepts. Thinking about relationships involves conceptualisation.
- The 'greater than' and 'less than' relationships, for example:
  - 6 is greater than 5 by 1,
  - 6 is greater than 4 by 2 and so on.
- As the one share increases from 0 to 6, the other share decreases from 6 to 0. This is a number pattern. Number patterns are also examples of mathematical relationships. (The picture illustrates this pattern.)

In the next activity, the learner is given the opportunity to develop concepts relating to Space and Shape.

 <p><b>Activity 6</b></p>	<p><b>Examples for the construction of concepts</b></p> <p>Allow a class to work through the example activity in the next box.</p> <p>As they do so, observe critically how the learners engage themselves with the task at hand:</p> <ul style="list-style-type: none"> <li>▪ What are the key concepts or ideas that learners need to make sense of?</li> <li>▪ Were the learners able to use their own level of reasoning and understanding? Diagnose some of the more interesting solution methods used.</li> <li>▪ Did the learners justify, test and explain their constructions? How consistent were they?</li> </ul>
--	--



### Example

#### Example activity: What shape?

In this activity we will be using only two types of cuts – horizontal and vertical cuts.

A vertical cut goes this way:

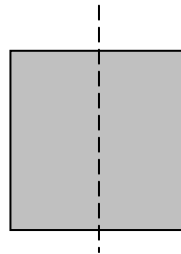

A horizontal cut goes this way:

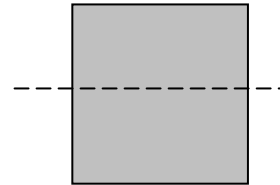

- 1 Choose an object in the classroom and show a friend how you would cut this object horizontally and then vertically.
- 2 Imagine that you are cutting these objects (vertically and then horizontally).
- 3 Draw the cross-section for each cut. What shape is each cross-section?

1.

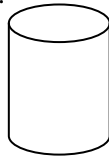

2.

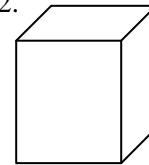

3.

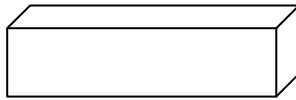

4.



5.

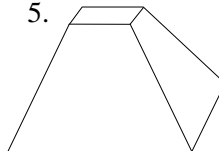

On the basis of your findings from this activity, what would you say are some of the advantages of using a problem-solving approach in developing conceptual understanding in the mathematics classroom?

### Developing procedures and processes

You must be wondering whether it would be prudent to use the problem-solving approach to learn basic skills and procedural skills. Must these be taught through direct instruction? Van de Walle (2004) emphasizes that learners can develop procedures via a problem-solving approach, and that problem solving is more effective than direct instruction for the teaching of basic skills and procedures. Think about the following informal constructions of procedures that learners could potentially connect as they develop new ideas:

1 Using the re-arranging principle to do calculations more quickly without a calculator:

$$\begin{aligned}
 63 + 84 &= 60 + 3 + 80 + 4 \\
 &= 60 + 80 + 3 + 4 \\
 &= 140 + 7 \\
 &= 147
 \end{aligned}$$

$$\begin{aligned}
 8 \times 9 \times 5 &= 8 \times 5 \times 9 \\
 &= 40 \times 9 \\
 &= 360
 \end{aligned}$$

$$\begin{aligned}
 25,64 + 53,93 &= 20 + 5 + 0,64 + 50 + 3 + 0,93 \\
 &= 20 + 50 + 5 + 3 + 0,64 + 0,93 \\
 &= 70 + 8 + 1,53 \\
 &= 78 + 1,53 \\
 &= 79,53
 \end{aligned}$$

2 Add and subtract the same number: (compensation)

$$\begin{aligned}
 19 - 8 &= (19 + 1) - (8 + 1) \\
 &= 20 - 9 \\
 &= 11
 \end{aligned}$$

$$\begin{aligned}
 37 - 18 \\
 &= (37 + 2) - (18 + 2) \\
 &= 39 - 20 \\
 &= 19
 \end{aligned}$$

$$\begin{aligned}
 18 + 24 &= (18 + 4) + (24 - 4) \\
 &= 22 + 20 \\
 &= 42
 \end{aligned}$$

3 Adding 'tens': to find the sum of 37 and 26

$$\begin{aligned}
 3\boxed{7} + 2\boxed{6} &\quad (\text{Boxed digits are held back}) \\
 30 + 20 &= 50 \\
 7 + 3 &= 10 \quad \boxed{3} \text{ is left from the 6} \\
 50 + 10 &= 60 \\
 60 + 3 &= 63
 \end{aligned}$$

#### 4 Solving an equation using 'Reverse operations'

Solve for  $x$

$$5x + 4 = 34$$

Let us write a flow diagram for this equation:

Start with  $x$

What must be done with  $x$  to get 34?

We must multiply it by 5 and then add 4

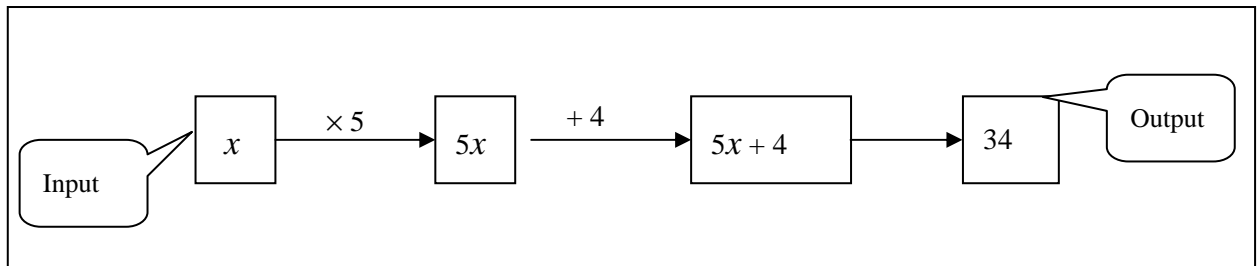

Now reverse the operations: (apply the inverse operations)

Start with the output (note the direction of the arrows change around)

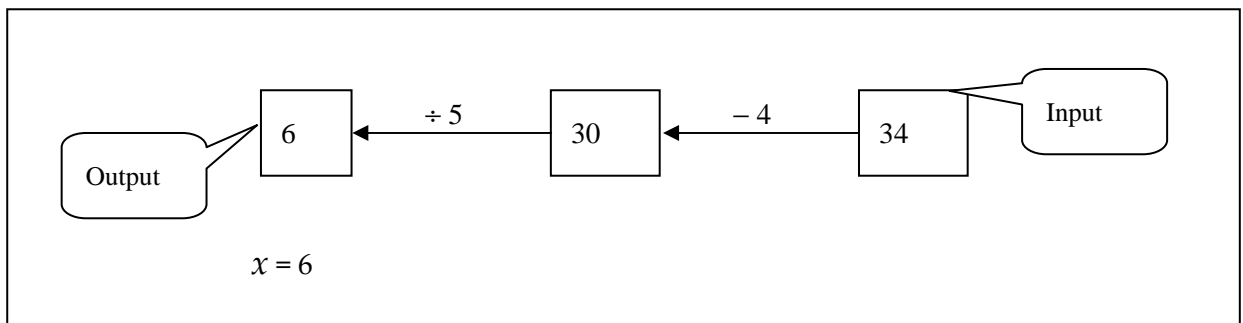

Pay attention to the application of inverse operations: (see the dotted lines)

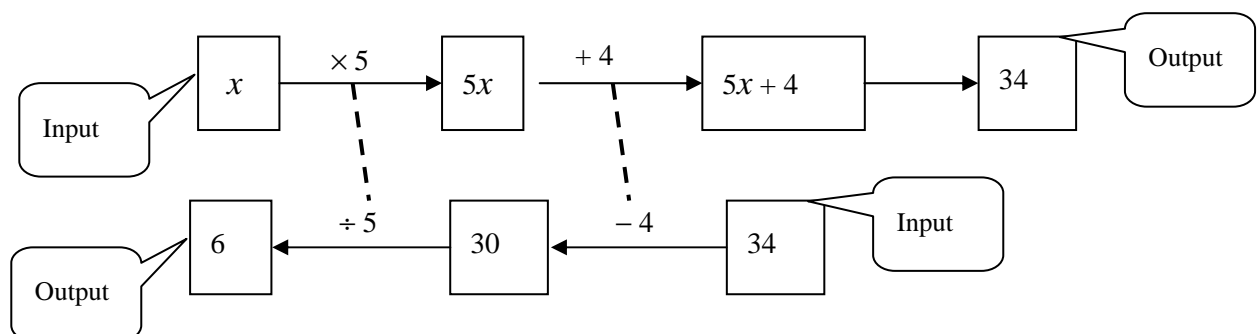

Problem solving should not be an isolated strand or topic in the already crowded curriculum. Rather, it should pervade the mathematics programme.



What advantages can you see in using a problem-based approach to develop procedural or process understanding?



### Activity 7

Grade 2 learners were challenged to find the sum of 48 and 25 and at least seven different solution methods were offered.

*Method 1*  
using a hundred square. Different counting methods are possible

Method 2

$$\begin{array}{l} 4\boxed{8} + 2\boxed{5} \\ 40 + 20 = 60 \\ \quad \quad \quad \boxed{3} \end{array}$$

$$\begin{array}{l} 8 + 2 = 10 \\ 60 + 10 = 70 \\ 70 + 3 = 73 \end{array}$$

Method 3

$$\begin{array}{l} 40 + 20 = 60 \\ 60 + 8 = 68 \\ 68 + 5 = 73 \end{array}$$

Method 4

$$\begin{array}{l} 48 + 20 = 68 \\ 68 + 2 = 70 \\ 70 + 3 = 73 \end{array}$$

Method 5

$$\begin{array}{l} 25 + 25 = 50 \quad \boxed{23} \\ 50 + 23 = 73 \end{array}$$

Method 6

$$\begin{array}{l} 48 - 3 = 45 \quad \boxed{3} \\ 45 + 25 = 70 \\ 70 + 3 = 73 \end{array}$$

Method 7

$$\begin{array}{l} 48 + 2 = 50 \quad \boxed{23} \\ 50 + 23 = 73 \end{array}$$

- 1 Analyse the solution methods offered by the learners and take note of the levels of thinking and the techniques constructed.
- 2 Are these invented methods efficient or adequate? Explain your answer.
- 3 Challenge your learners to use informal methods (or their own constructions and procedures) to do some of the calculations given above.

For example:

$$83 + 76$$

$$15,34 + 12,67$$

$$37 - 25$$

$$5 \times (7 + 2)$$

$$8 \times 9 \times 5$$

## Good problems have multiple entry points

Recall that one advantage of a problem-based approach is that it can help accommodate the diversity of learners in every classroom. Teachers should not dictate how learners must think about a problem in order to solve it. When a task is posed, the learners could be told: ‘Use the ideas you own to solve this problem’.

The learners in a class will have different ideas about how they can best solve a problem. They will draw on their own network of mental tools, concepts and ideas. This means that there will be many ways to tackle the problem - multiple entry points. Although most problems have singular correct answers, there are often many ways to get there.

Here is an example of a problem:

Find the area of your mathematics book. That is, how many square tiles will fit on the cover of the book?

Some different solution methods at different entry points are reflected in the frames shown below:

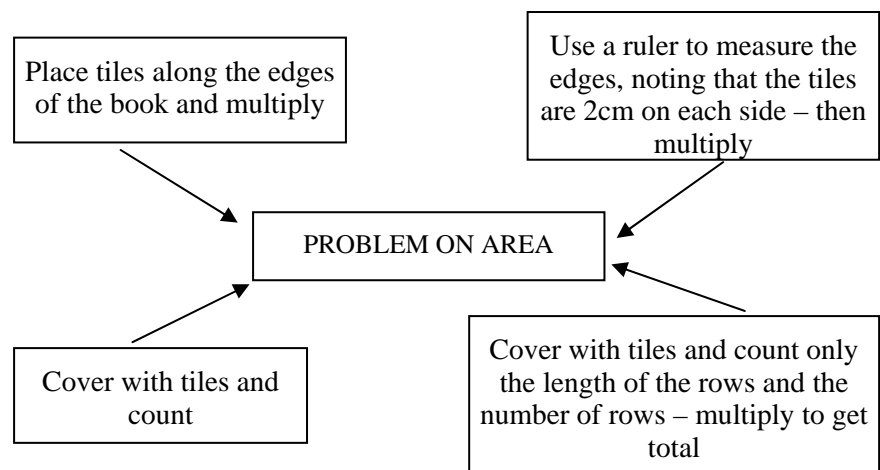

Having thought about these possible points, you will be better prepared to provide a hint that is appropriate for learners who are ‘stuck’ – with strategies different to the others.

## Designing and selecting effective tasks

As we said above, an effective task is one that helps learners to construct the ideas you want them to learn. When you are planning a lesson, part of your work is to select (or design) tasks that will facilitate the learning of the mathematical content to be covered in that lesson.

Therefore, the first and most important consideration for selecting any task for your class must be the mathematics that learners need to master and where they are in relation to that need at the moment. You could look for tasks to use in your mathematics teaching from textbooks, children’s literature, the popular media, and the internet.

Most teachers use their textbooks as the everyday guide to the curriculum. (All teachers should have copies of their own textbooks to draw on for ideas and problem-solving activities even if the learners in their classes do not have them.) Many of the new textbooks are written with the learner in mind and they contain challenging and stimulating activities in which learners can be engaged.

However, there is always an opportunity for teachers to adapt textbook activities so that they are more suitable for the particular situation of their learners. Teachers can also design their own activities with the specific needs of their learners in mind.

There are four basic steps that can guide you in selecting (and/or designing) activities.

#### STEP 1: How is the activity done?

- Do the activity! This enables you to get 'inside' the activity and find out the sort of thinking that is required.
- Think about how the learners might do the activity or solve the problem. Anticipate any difficulties that might arise.
- Think about how you will prepare the learners for the activity.
- Note what materials are required and what needs to be written down or recorded.

#### STEP 2: What are the desired outcomes of the activity

- What are the learning outcomes for the activity? These might be the LOs from the curriculum statement or Activity Outcomes that you decide upon.
- What mathematical ideas/concepts will the activity develop?

#### STEP 3: Will the activity allow learners to achieve the outcomes?

- What is the 'problem' in the activity?
- What must the learners reflect on or think about to complete the activity?
- Is it possible to complete the activity without much thought? If so, can you change it so that the learners are required to think more about the mathematics?

#### STEP 4: What assessment will you include with the activity?

- The assessment must be part of the planning of the activity
- What you assess and how you assess it, is a crucial feature of the activity.
- How will the learners demonstrate their understanding?

In this section we have used a number of examples to help identify some of the characteristics of problem-solving tasks. Looking at these examples, what would you say are the advantages of using these kinds of tasks over the more traditional rule-example-drill approach?

## A three-part lesson format

You may be inclined to agree that teachers typically spend a small portion of the allocated time in explaining or reviewing an idea, followed by learners working through a list of exercises – and more often than not, rehearsing the procedures already memorized. This approach conditions the learners to focus on procedures so that they can get through the exercises.

This is in stark contrast to a lesson where a class works on a single problem and engages in discourse about the validity of the solution – more learning occurs and much more assessment information is available.

### Before, during and after

Teaching through problem solving does not mean simply providing a problem or task, sitting back and waiting for something to happen. The teacher is responsible for making the atmosphere and the lesson work. To this end, Van de Walle (2004) sees a lesson as consisting of three main parts: before, during and after. He proposes the following simple three-part structure for lessons when teaching through problem solving (p.42):

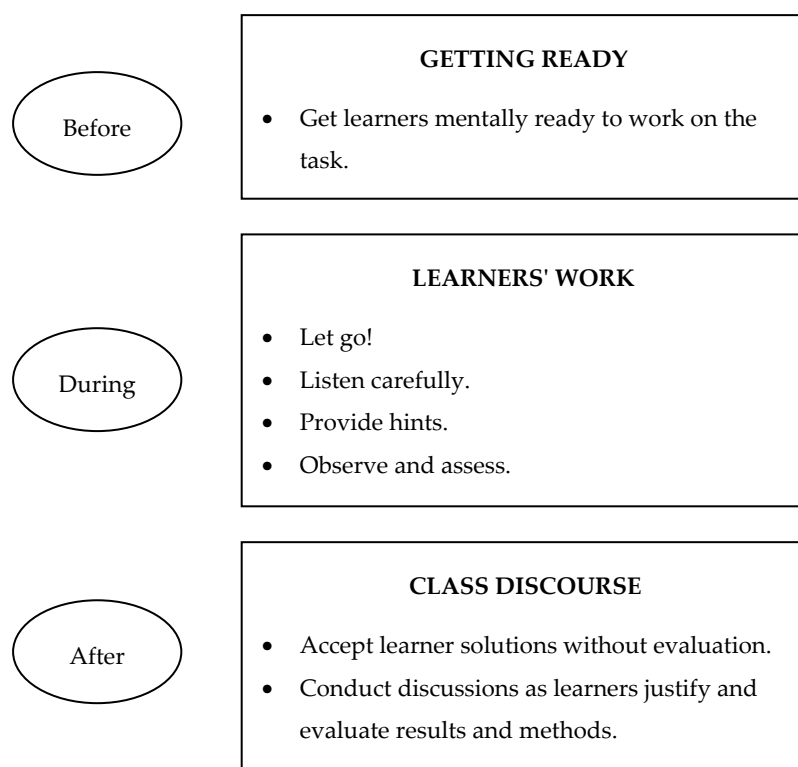

If you allow time for each of the before, during and after parts of the lesson, it is quite easy to devote a full period to one seemingly simple problem. In fact, there are times when the ‘during’ and ‘after’ portions extend into the next day or even longer!

As long as the problematic feature of the task is the mathematics you want learners to learn, a lot of good learning will result from engaging learners in only one problem at a time.



### Activity 8

#### Lessons – before, during and after

Each of the main three parts of a lesson – before, during and after – are considered critical for successful problem-solving lessons.

- 1 Analyse the three-part structure of a lesson described above.
- 2 What is the teacher’s purpose or agenda in each of the three parts of a lesson – before, during and after?
- 3 Compare critically the three-part structure of a lesson proposed here to the structure of a routine lesson conducted in your classroom. What are the implications of this comparison to your teaching? You may discuss this with some of your colleagues.

### Teacher’s actions in the before phase

What you do in the before phase of a lesson will vary with the task. The actual presentation of the task or problem may occur at the beginning or at the end of your ‘before actions’. However, you will have to first engage learners in some form of activity directly related to the problem in order to get them mentally prepared and to make clear all expectations in solving the problem.

The following strategies may be used in the before-phase of the lesson:

- Begin with a simple version of the task – reduce the task to simpler terms.
- Brainstorm: where the task is not straight forward, have the learners suggest solutions and strategies – producing a variety of solutions.
- Estimate or use mental computation – for the development of computational procedure, have the learners do the computation mentally or estimate the answer independently.
- Be sure the task is understood – this action is not optional. You must always be sure that learners understand the problem before setting them to work. Remember that their perspective is different from yours. Have them restate the problem in their own words – this will force them to think about the problem.

- Establish expectations. This action is essential. Learners need to be clearly told what is expected of them. For example:
  - Explain (in writing) why you think your answer is correct.
  - When learners are working in groups, only one written explanation should come from the group.
  - Share your ideas with a partner and then select the best approach to be presented.



Activity 9

A problem-solving approach to an activity

Consider the following problem that is designed to develop some ideas about area and perimeter for intermediate phase learners:

Problem

Assume that the edge of a square is 1 unit. Add squares to this shape so that it has perimeter of 14 units and 15 units

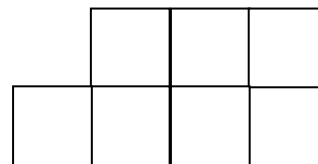

- Show how you would use a simple version of the task to solve the problem.
- Challenge your learners with this problem. Take note of their level of reasoning, constructions and manipulations. You may provide them with some square tiles.
- What prior knowledge would the learners require to understand the problem? Explain.

Things to think about

Consider the following option: Adding one square tile at a time – along one edge. P is the perimeter.



P = 4

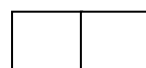

P = 6  
and so on

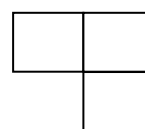

P = 8

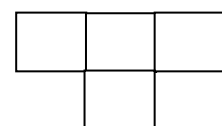

P = 10

Find a pattern and solve the problem.

To ensure that learners understand the problem, pose the following question:

What is meant by

- 1 an edge?
- 2 the perimeter?
- 3 a square unit?
- 4 the area?

### Teacher's actions in the during phase

Once you are comfortable that learners are ready to work on the task, it is time to let go – your role now shifts to that of a facilitator:

- You must demonstrate confidence and respect for your learners' abilities.
- Your learners should get into the habit of working in groups – to indulge in co-operative group work.
- Listen actively – find out what your learners know, how they think, and how they are approaching the task.
- Provide hints and suggestions – when the group is searching for a place to begin, when they stumble. Suggest that they use a particular manipulative or draw a picture if that seems appropriate.
- Encourage testing of ideas. Avoid being the source of approval for their results or ideas. Instead, remind the learners that answers, without testing and without reasons, are not acceptable.
- Find a second method. This shifts the value system in the classroom from answers to processes and thinking. It is a good way for learners to make new and different connections. The second method can also help learners who have made an error to find their own mistake.
- Suggest extensions or generalisations. Many of the good problems are simple on the surface. It is the extensions that are excellent.

The general question at the heart of mathematics as a science of pattern and order is: *What can you find out about that?*  
This question looks at something interesting to generalise.

The following questions help to suggest different extensions:  
*What if you tried.....? Would the idea work for .....?*

### Teacher's actions in the after phase

This 'after' phase is critical – it is often where everyone, learners as well as the teacher, learn the most. It is not a time to check answers, but for the class to share ideas. As Van de Walle comments (2005:46):

*Over time, you will develop your class into a community of learners*

*who together are involved in making sense of mathematics. Teach your learners about your expectations for this time and how to interact with their peers.*

In the 'after phase' of a lesson, teachers may find that they will engage in the following activities:

**Engage the class in discussion.**

Rule number one is that the discussion is more important than hearing an answer. Learners must be encouraged to share and explore the variety of strategies, ideas and solutions – and then to communicate these ideas in a rich mathematical discourse.

**List the answers of all groups on the board without comment.**

Unrelated ideas should be listened to with interest, even if they are incorrect. These can be written on the board and testing the hypothesis may become the problem for another day – until additional evidence comes up that either supports or disproves it.

**Give learners space to explain their solutions and processes.**

A suggestion here is to begin discussion by calling first on children who are shy, passive or lack the ability to express themselves – because the more obvious ideas are generally given at the outset of a discussion. These reticent learners can then more easily participate and thus be valued.

**Allow learners to defend their answers, and then open the discussion to the class. Resist the temptation to judge the correctness of an answer.**

In place of comments that are judgemental, make comments that encourage learners to extend their answers, and that show you are genuinely interested. For example: 'Please tell me how you worked that out.'

**Make sure that all learners participate, that all listen, and that all understand what is being said.**

**Encourage learners to ask questions, and use praise cautiously.**

You should be cautious when using expressions of praise, especially with respect to learners' products and solutions. 'Good job' says 'Yes, you did that correctly'. However, 'nice work' can create an expectation for others that products must be neat or beautiful in order to have value – it is not neatness, but good mathematics that is the goal of mathematics teaching.





## Activity 10

**Devising a three-part lesson format for an activity in the classroom**

For this activity, you are required to select an activity from any source. You must give the reference for the activity that you have selected.

- 1 How can the activity be used as a problem or task for the purpose of instruction (as described in the study unit)? Explain.
- 2 If you were using this activity in the classroom, what specifically would you do during each of the 'before, during and after' section of the lesson? Describe each part clearly.
- 3 Consider that for the purpose of instruction the problem needs to be acted upon through the teacher actions identified for the 'before, during and after' phase of the lesson.
- 4 What do you expect the learners to do during each of the phases of the lesson?

### Working towards problem-solving goals

All of the goals of problem solving can and will be attained in a classroom that employs a problem-solving approach and allows the learners to use and develop their problem-solving strategies. It is important for the teacher to be clearly aware of the goals of problem solving and focus attention on them regularly.

Three important goals of teaching through problem solving are:

- Allow learners to develop problem-solving strategies – strategies for understanding the problem (the before phase of a lesson).
- Plan-and-carry-out-strategies (the before and during phase of the lesson).
- Reflect on the problem-solving process to ensure that learning has taken place, and to consolidate the learning that has taken place (the after phase of the lesson).

Some practical problem solving strategies are:

- Draw a picture, act it out, use a model.
- Look for a pattern.
- Make a table or chart.
- Try a simpler form of the problem.
- Guess and check.
- Make an organised list.

Some looking-back strategies are:

- Justify the answer.
- Look for extensions to the solution.
- Look for generalisations of the solution.

### Different levels of cognitive demands in tasks

An important practical step that every teacher makes daily in working towards problem-solving goals is the selection of tasks for learners to work on. Teachers do this with more or less thought on different occasions. The tasks that learners work on will influence their experiences of mathematics and are vital in their construction of knowledge and their mathematical development. It is important that mathematics teachers are able to choose tasks carefully and thoughtfully, in order to achieve their goals for their learners' learning. This is particularly the case when working with new concepts of mathematics and learning.

Stein et al (2000) give a framework for differentiating between tasks, describing the different levels of thinking that they require in order for learners to be successfully engaged. They distinguish between tasks that have low-level demands, such as memorisation and purely procedural tasks, and those that demand a high-level of mathematical thinking, such as procedural tasks that link to enhancing understanding and sense-making and those tasks that involve learners in 'doing mathematics' as they explore relationships and understand mathematical concepts and processes.

The table on the next page summarises the main features of the task analysis suggested by Stein et al (2000).

Lower-level demands	Higher level demands
<i>Memorization tasks</i>	<i>Procedures with connections tasks</i>
<p>Involve reproducing previously learned facts, rules, formulae or definitions</p> <p>Cannot be solved using a procedure</p> <p>Are not ambiguous – involve exact reproduction of previously seen material</p> <p>Have no connection to concepts or meanings that underline the facts, etc. being learned or reproduced</p>	<p>Focus on the use of procedures for the purpose of developing deeper levels of understanding</p> <p>Suggest pathways to follow</p> <p>Are usually represented in multiple ways, e.g. diagrams, manipulative, symbols, etc.</p> <p>Require some degree of cognitive effort. Learners are required to engage with conceptual ideas that underlie procedures to be successful</p>
<i>Procedures without connections</i>	<i>Doing mathematics tasks</i>
<p>Are algorithmic</p> <p>Require limited cognitive effort for success.</p> <p>There is little ambiguity of what needs to be done and how to do it</p> <p>Have no connections to concepts or meanings that underlie the procedure</p> <p>Require no explanations or very few descriptions of how procedures work</p>	<p>Require complex and non-algorithmic thinking</p> <p>Require learners to explore and understand mathematical concepts, processes or relationships</p> <p>Demand self-regulation</p> <p>Require learners to access relevant knowledge</p> <p>Require learners to analyse the task</p> <p>Require considerable cognitive effort and may lead to some levels of anxiety due to unpredictable nature of the solution process</p>

This information on the different levels of cognitive demand in tasks, and the activity that follows comes from the *Mathematical Reasoning* guide developed by RADMASTE (2006).



## Activity 11

## Different levels of cognitive demand in tasks

- 1 Select an LO for an activity/task for the learners in one of your classes.
- 2 Design an activity/task that promotes high-level thinking in terms of Stein et al's categories. Clearly identify the Activity Outcomes.
- 3 Write a separate response to the questions below:
  - State the category into which you think your task falls.
  - Explain why you think your task falls within this category.
  - Write a paragraph describing to what extent and in what ways you think the task might promote mathematical reasoning.
- 4 A task is given in the Example below.
  - Read through the task carefully and make sure you understand what the learners are required to do.
  - Identify the LO under which it might fall and a class you teach that you might be able to give the task to. Write out the activity outcomes for the task.
  - Evaluate the task in terms of Stein et al's categories stating clearly why you think the task falls within a selected category. Comment on flaws, if any, that you can identify in the task and suggest changes if appropriate.
  - Write a paragraph saying in what ways you think the task might promote mathematical reasoning.

In order to answer these questions you will need to think about many of the issues you have studied so far in this module, in particular:

- What is meant by mathematical reasoning?
- How can you use tasks to develop learners' thinking and reasoning?
- Understanding how learners construct meaning.

**Example E**
**Example task with different levels of cognitive demand**

If a grown man and a small boy sit on opposite ends of a see-saw, what happens? Would changing or moving the weight on one end of the seesaw affect the balance? You'll find out as you do this experiment.

**YOU WILL NEED:** a pencil, a 30cm ruler, nine 5 cent pieces

**Step 1:** On a flat desk, try to balance a ruler across a pencil near the 15cm mark.

**Step 2:** Stack two 5c pieces on the ruler so that they are centred at the 5 cm mark to the right of the pencil. You may need to tape them in place.

**Step 3:** Place one 5c piece on the left side of the ruler so that it balances the two on the right hand side. Be sure that the ruler stays centred over the pencil. How far from the pencil is the one 5c piece?

**Step 4:** Repeat step 3 for two, three, four and six 5c pieces on the left side of the ruler. Measure to the nearest 1 mm. Copy and complete the table.

Left side		Right side	
Number of 5c	Distance	Number of 5 c	Distance
1		2	5
2		2	5
3		2	5
4		2	5
6		2	5

**Step 5:** As you increase the number of 5c pieces on the left hand side how does the distance change? What relationship do you notice?

**Step 6:** Make a new table and repeat the investigation with three 5-cent pieces stacked to the right of the centre. Does the same relationship hold true?

**Step 7:** Review the data in your tables. How does the number of 5c pieces on the left and their distance from the pencil compare to the number of pieces on the right and their distance from the pencil? In each table do the quantities remain the same? Write a sentence using the words left 5c pieces, right 5c pieces, left distance and right distance to explain the relationship between the quantities. Define variables and rewrite your sentence as an equation.

**Step 8:** Explain why you think the relationship between the number of 5 cent pieces and the distance from the pencil might be called an inverse relationship.

## The value of teaching using a problem based approach

Teaching using a problem-based approach requires the development of tasks that take into account the current understanding of learners, as well as the needs of the curriculum. The value of this approach includes:

- When solving problems, learners focus their attention on ideas and sense-making. This leads to the development of new ideas and enhances understanding. In contrast a more traditional approach emphasises ‘getting it right’ and following the directions supplied by the teacher.
- When solving problems, learners are encouraged to think that they can do mathematics and that mathematics makes sense. As learners develop their understanding, their confidence in mathematics is also developed.
- As learners discuss ideas, draw pictures, defend their own solutions and evaluate other solutions and write explanations they provide the teacher with an insight into their thought process and their mathematical progress.
- In solving problems, learners develop reasoning and communication, and make connections with existing knowledge. These are the processes of ‘doing’ mathematics that go beyond the understanding of mathematical content.
- A problem-based approach is more rewarding and more stimulating than a teach-by-telling approach. Learners are actively engaged in making sense of, and solving the problem. The development of their understanding is exciting for the learners and the teacher.

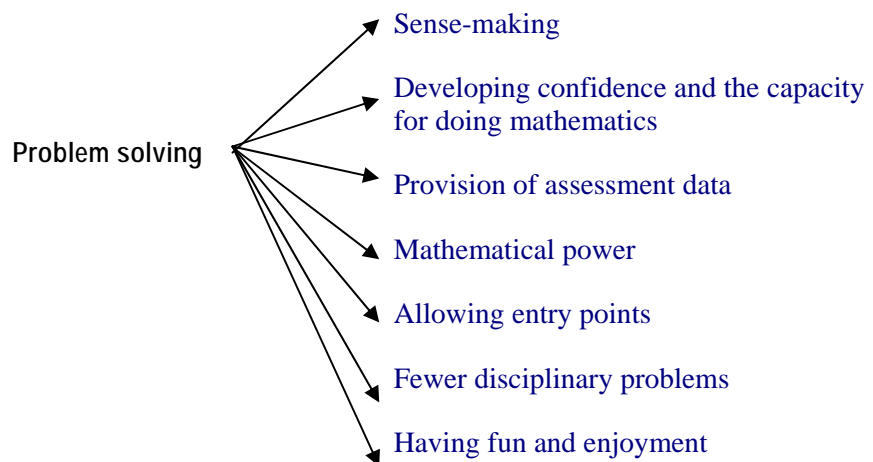

It is not difficult to teach mathematics as a series of skills and a collection of facts; to programme learners to be able to carry out routine procedures without really having to think about what they are actually doing. From the learners who emerge at the end of the system, and who go into the world, only a small percentage have any use at all for the mathematics they have learnt, and most will use their knowledge of simple arithmetic assisted by the pocket calculator, to get them through everyday life. So do you agree that there must be more to the teaching of mathematics than simply being able to do calculations, solving equations or being able to memorise theories?

---

## Unit summary

What is problem solving as envisioned in the South African situation? It is not simply instruction for problem solving or about problem solving. Campbell (1990) explains that problem solving is when:

- learners are actively involved in constructing mathematics.
- there is cooperation and questioning as learners acquire, relate and apply new mathematical ideas through sharing, inquiring and discussing.
- learners are communicating mathematical ideas through sharing, inquiring and discussing.
- learners are investigating relationships, and the problems act as a catalyst for connecting mathematical concepts and skills.
- learners are selecting strategies, justifying solutions, extending and generalising problems.

Given the already crowded curriculum in mathematics, how and when can a teacher include long-term problem-solving activities? The key is the approach taken to problem-solving instruction. It should not be an isolated strand or topic in the already crowded curriculum – it helps to accommodate the diversity of learners in every classroom. The Equity Principle challenges teachers to believe that every learner brings something of value to the tasks that they pose to their class.

Problem solving is an integral part of **all mathematics learning**.

Recall that learners must engage in tasks and activities that are problem-based and require thought. Learning takes place as a result of problem solving and the mathematical ideas are the outcomes of the problem-solving experience.

So we see that the activity of solving problems is now completely interwoven with the learning – the children are learning mathematics by doing mathematics.



## Activity 12

Now let us put into practice what we have explored in this unit.

- 1 Look through your current teaching plans. Choose a concept/topic which you had planned to teach in a more traditional way based on past experience but which you realise you could now use problem solving for.
- 2 Redesign and teach the lesson using problem solving as your main teaching strategy.
- 3 After the lesson write a comparison between the lesson as you taught it now and then.
  - What did you and the learners do differently?
  - Did learners learn any better or worse when you used this new approach?
  - What evidence did you use to answer the previous question?

## Self assessment



## Assessment

Tick the boxes to assess whether you have achieved the outcomes for this unit. If you cannot tick the boxes, you should go back and work through the relevant part in the unit again.

I am able to:

#	Checklist	<input checked="" type="checkbox"/>
1	Motivate with understanding the need for a shift in thinking about mathematics instruction.	<input type="checkbox"/>
2	Critically reflect on the value of teaching with problems.	<input type="checkbox"/>
3	Select and analyse appropriate tasks and problems for learning mathematics.	<input type="checkbox"/>
4	Describe with insight the three-part lesson format for problem solving referred to as before, during and after.	<input type="checkbox"/>
5	Critically describe the teacher's actions in the before, during and after phases of a problem-solving lesson.	<input type="checkbox"/>
6	Competently select and design effective problem-based lessons from the textbook and other resources.	<input type="checkbox"/>
7	Explain competently how problem-solving goals are developed while students learn.	<input type="checkbox"/>



---

## References



- Bell, FH (1982). *Teaching and learning mathematics*. WM.C.Brown Publishers: Iowa.
- Campbell, P.E., & Bamberger, HJ (1990). Implementing Standards. In TE Rowan (Ed), *The vision of problem solving in the Standards*. Arithmetic Teacher, Vol 37, Number 9, Reston, V.A. NCTM.
- Department of Education (2001). *Revised national curriculum statement of grades R-9 (schools)*.
- Hiebert et al (1997). *Making sense: teaching and learning mathematics with understanding*. Partmouth, NH: Heinemann.
- Malati (1999). *Geometry Module 3: Representations (nets, models and cross-sections), Grades 4 to 7 Learner Materials*.
- NCTM (1989). *Commission on standards and evaluation for school mathematics*. Reston, VA. NCTM.
- Nicholson, MJ (1992). Problem solving. In M Moodley et al, *Mathematics education for in-service and pre-service teachers*. Shuter & Shooter: Pietermaritzburg.
- Polya, G (1980). On solving mathematical problems in high school. IN NCTM, *Problem solving in school mathematics 1980 Yearbook*. NCTM.
- RADMASTE Centre, University of the Witwatersrand (2006). *Mathematical Reasoning*. (EDUC 263). Chapter 7.
- Stein, MK et al (2000). *Implementing standards-based mathematics instruction: A casebook for professional development*. New York: Teachers' College Press.
- Van de Walle, JA (2004). *Elementary and middle school mathematics – teaching developmentally*. New York: Pearson.